

Five Seating System

designed by Marcel Wanders Studio

Struttura — Schienale in legno imbottito con poliuretano espanso e fibra di poliestere. **Seduta** — Cornice interna in legno con cinghie elastiche. Sedile imbottito con poliuretano espanso e fibra di poliestere. **Base** — Lamiera d'acciaio da 8 mm, tagliata a laser e piegata a freddo. Finiture Brushed Gunmetal, Gold Shadow o Old Bronze. **Rivestimento** — Non sfoderabile, in tessuto o pelle. **Profili seduta e schienale** — Disponibili in pelle Palio, pelle Signoria, o pelle nera intrecciata con nabuk grigio. **Cuscini** — Disponibili in tre formati: 800×500 mm con profili e bottone centrale, 500×350 mm con profili e bottone centrale, 350×250 mm con profili. **Tavolino** — Tavolino con cassetto push-pull in legno laccato, rivestito con lastre di marmo di spessore 20 mm. Interno del cassetto rivestito in microfibra. Disponibile nei marmi della collezione, finitura lucida.

Frame — Wood backrest padded with polyurethane foam and polyester fibre filler. **Seat** — Internal wood frame with elastic webbing. Seat padded with polyurethane foam and polyester fibre filler. **Base** — 8 mm steel sheet structure, laser cut and cold bent. Available with Brushed Gunmetal, Gold Shadow or Old Bronze finishes. **Upholstery** — Non-removable fabric or leather cover. **Seat and backrest piping** — Available in Palio leather, Signoria leather or in black leather interlaced with grey nubuck. **Cushions** — Loose cushions available in three sizes: 800 mm × 500 mm with piping and central button; 500 mm × 350 mm with piping and central button; 350 mm × 250 mm with piping. **Table** — Small table with push-pull drawer in lacquered wood with 20 mm thick marble top. Drawer interior lined in microfibre. Available in the same marble of the collection with glossy finish.



006 025 — Left 3-seater corner with large side table on the right
006 005 — Right chaise longue



Five Seating System

006 002 — 2-seater sofa

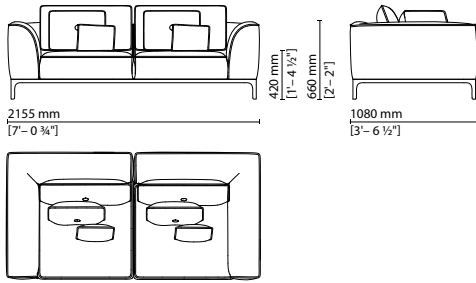

006 003 — 3-seater sofa

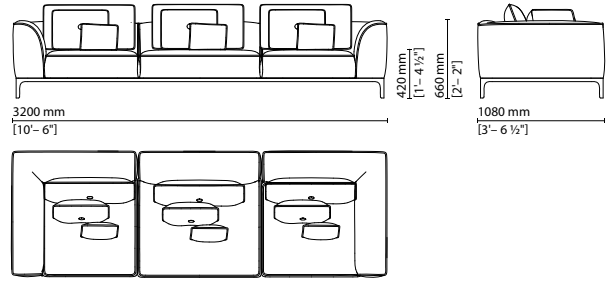

006 004 — Left chaise longue

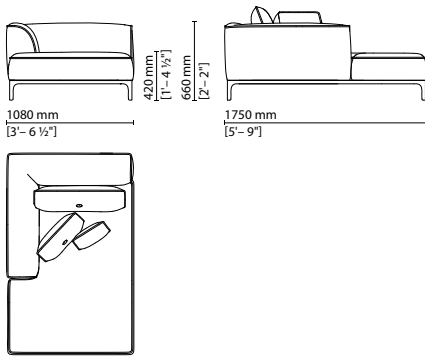

006 005 — Right chaise longue

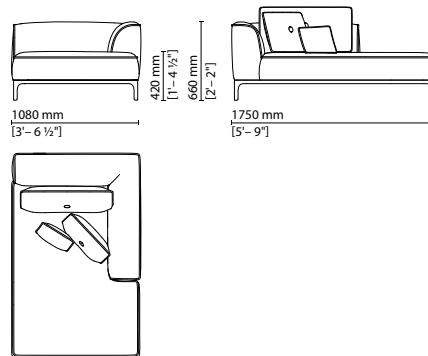

006 006 — Left corner chaise longue

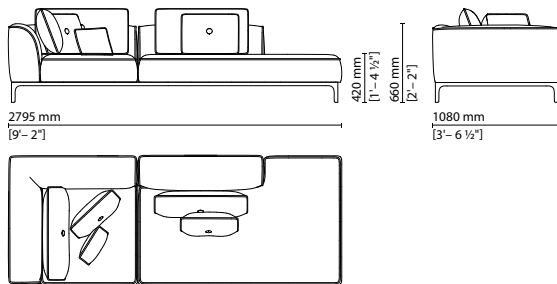

006 007 — Right corner chaise longue

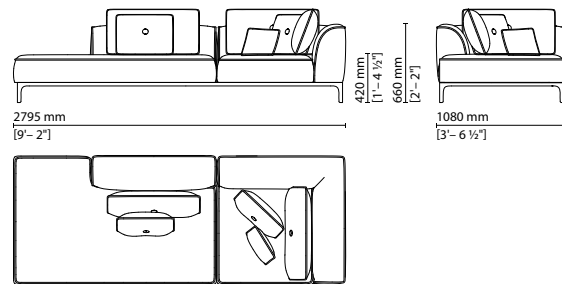

006 008 — Left corner 2-seater

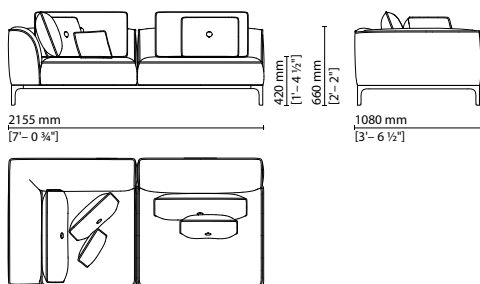

006 009 — Right corner 2-seater

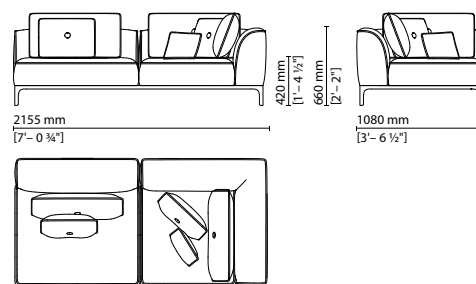

Five Seating System

designed by Marcel Wanders Studio

006 010 — Left 2-seater with small side table

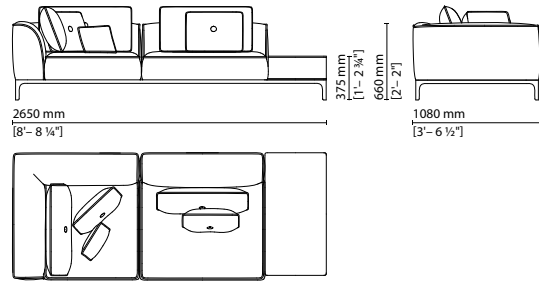

006 011 — Right 2-seater with small side table

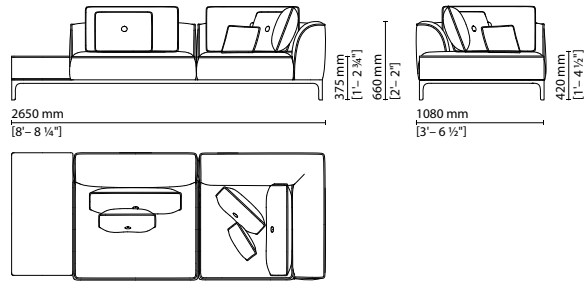

006 012 — Left corner element 3-seater

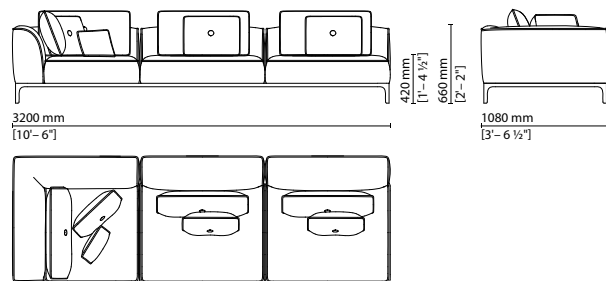

006 013 — Right corner element 3-seater

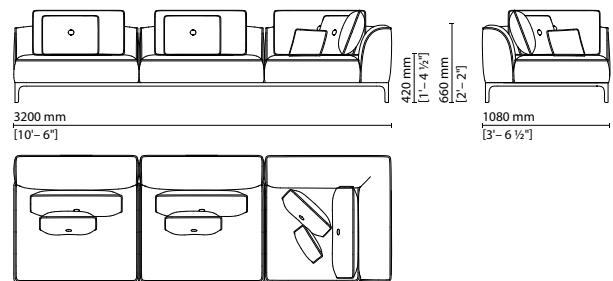

006 021 — Left corner element with large side table on the right

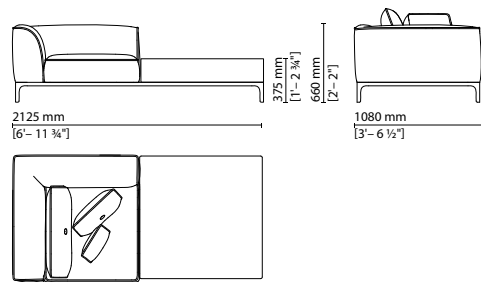

006 022 — Right corner element with large side table on the left

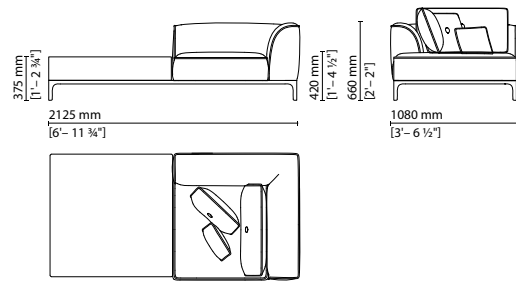

006 023 — 2-seater sofa with small side table on the right

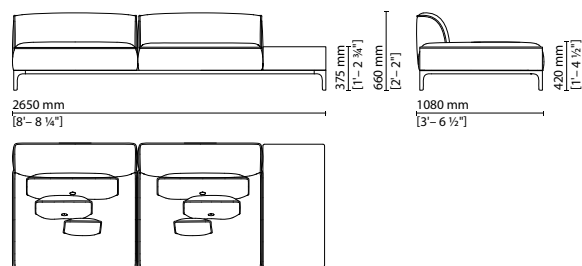

006 024 — 2-seater sofa with small side table on the left

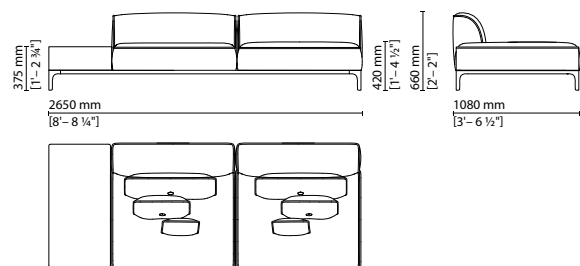

Five Seating System

006 025 — Left 3-seater corner with large side table on the right

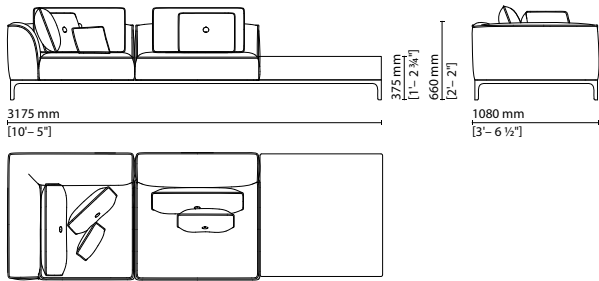

006 026 — Right 3-seater corner with large side table on the left

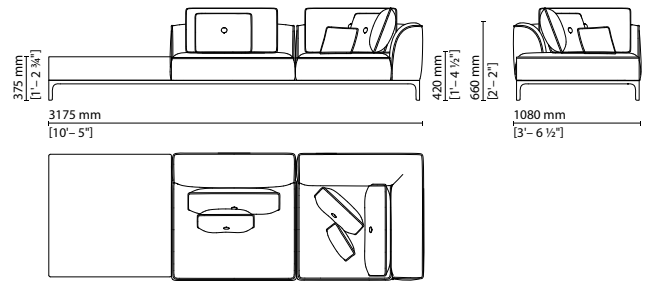

006 027 — Left 3-seater corner with large central coffee table

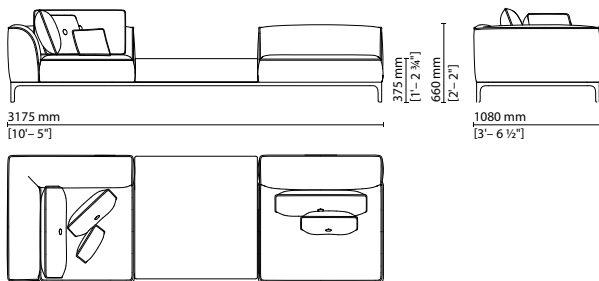

006 028 — Right 3-seater corner with large central coffee table

