

**BENTLEY HOME**  
living / coffee tables  
**THAMES**



**BENTLEY**

HOME



# BENTLEY HOME

## living / coffee tables

### THAMES



BENTLEY

HOME

#### DESCRIZIONE TECNICA / TECHNICAL DESCRIPTION

**GAMBE** Legno rivestito con Paper Factor®, composto di micro-fibre di carta/cellulosa, colore Veins Black Grey oppure Veins Burgundy  
Versione alternativa in legno impiallacciato Warm Grey Fiddleback Sycamore, Smoked Liquidambar, radica Burr Walnut, finitura lucida spazzolata

**TOP** Legno rivestito con Paper Factor®, composto di micro-fibre di carta/cellulosa, colore Veins Black Grey oppure Veins Burgundy  
Versione alternativa in legno impiallacciato Warm Grey Fiddleback Sycamore, Smoked Liquidambar o radica Burr Walnut, con speciale laccatura effetto Degradé Lacquer, finitura lucida spazzolata (data di consegna indicata sulla conferma d'ordine)

**OPTIONAL** Top aggiuntivo in legno laccato lucido spazzolato, per composizione a tre top

**Top laccato burgundy**, abbinabile a:

-due coffee table con top Paper Factor® colore Veins Burgundy

**Top laccato nero**, abbinabile a:

-due coffee table con top Paper Factor® colore Veins Black Grey  
-due coffee table con top impiallacciato Smoked Liquidambar oppure Burr Walnut con speciale laccatura effetto Degradé Lacquer

**Top laccato Deep Ocean**, abbinabile a:

-due coffee table con top impiallacciato Warm Grey Fiddleback Sycamore con speciale laccatura effetto Degradé Lacquer

**LEGS** Wood covered with Paper Factor®, made from a paper micro cellulose compound, Veins Black Grey or Veins Burgundy colour

Alternative version in wood veneered Warm Grey Fiddleback Sycamore, Smoked Liquidambar or Burr Walnut briar-root, glossy brushed finishing

**TOP** Wood covered with Paper Factor®, made from a paper micro cellulose compound, Veins Black Grey or Veins Burgundy colour

Alternative version in wood veneered Warm Grey Fiddleback Sycamore, Smoked Liquidambar or Burr Walnut briar-root with special lacquering Degradé Lacquer effect, glossy brushed finishing (delivery date indicated on the confirmation of the order)

**OPTIONAL** Additional wooden top with glossy brushed lacquering, for three tops composition

**Burgundy lacquered top**, can be combined with:

-two coffee tables with Paper Factor® top, colour Veins Burgundy

**Black lacquered top**, can be combined with:

- two coffee tables with Paper Factor® top, colour Veins Black Grey  
- two coffee tables with Smoked Liquidambar or Burr Walnut veneered top and special lacquering Degradé Lacquer effect

**Deep Ocean lacquered top**, can be combined with:

-two coffee tables with Warm Grey Fiddleback Sycamore veneered top and special lacquering Degradé Lacquer effect

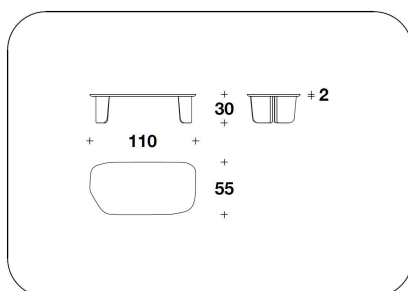

CTB (39E) - CTB (39CA)  
COFFEE TABLE  
110x55x32H.cm  
43 1/3x21 2/3x12 2/4H."

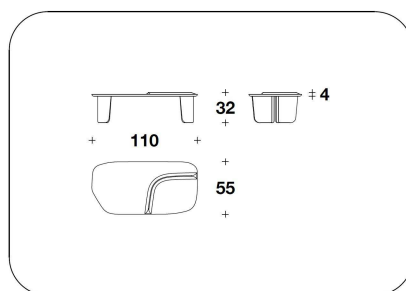

CTB (39E) - CTB (39CA)  
COFFEE TABLE  
110x55x32H.cm  
43 1/3x21 2/3x12 2/4H."

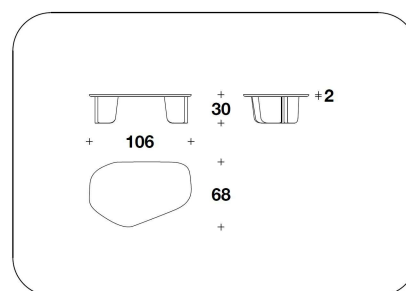

CTB (40E) - CTB (40CA)  
COFFEE TABLE  
106x68x32H.cm  
41 2/3x26 2/3x12 2/4H."

**BENTLEY HOME**  
**living / coffee tables**  
**THAMES**



**BENTLEY**

HOME

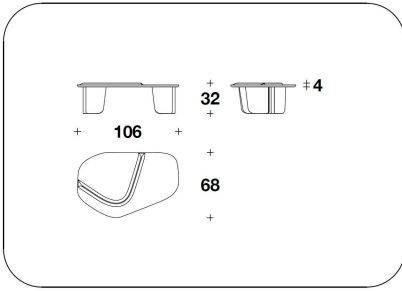

CTB (40E) - CTB (40CA)  
 COFFEE TABLE  
 106x68x32H.cm  
 41 2/3x26 2/3x12 2/4H."

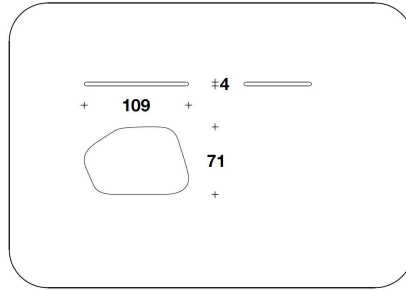

CTB (41L)  
 OPTIONAL TOP  
 109x71x4H.cm  
 43x28x1 9/16H."

**Note**

**EXAMPLE OF COMPOSITIONS**

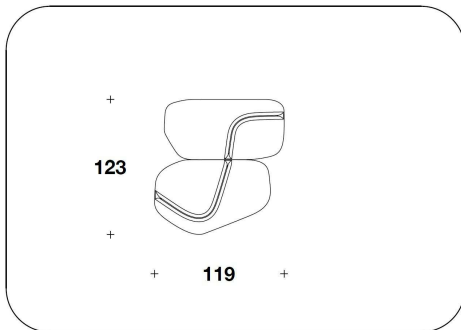

CTB (39CA) + CTB (40CA)

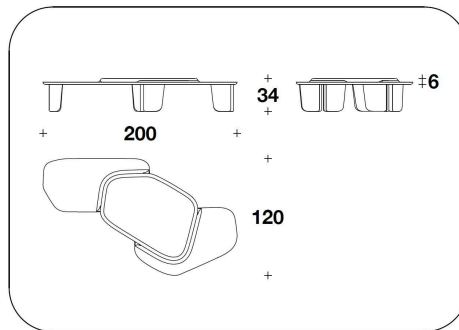

CTB (40E) + CTB (39E) + CTB (41L)